

 ROOFLIGHT MUST BE INSTALLED ON A PITCH BETWEEN 3-30° TO AVOID ANY WATER POOLING

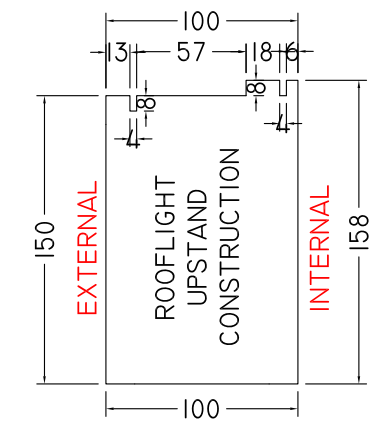

	
<small>DETAILS ON THIS DRAWING ARE THE COPYRIGHT OF RED ROOFLIGHTS AND MUST NOT BE REPRODUCED IN WHOLE OR PART WITHOUT PERMISSION</small>	
DO NOT SCALE	
TITLE 1500x1000MM FIXED ROOFLIGHT NO UPSTAND	
SCALE 1:4 @ A3	DATE JULY '16
DRAWING No. RED.LID.003	REV. 0
CONSTRUCTION ISSUE	